

*Expertise in medicine and science
and how it is best learned and taught***

Carl Wieman

Stanford University

Department of Physics and Grad School of Education

copies of slides will be available

*based on the research of many people, some from my science ed research group

Major advances past 1-2 decades ⇒ Guiding principles for achieving learning

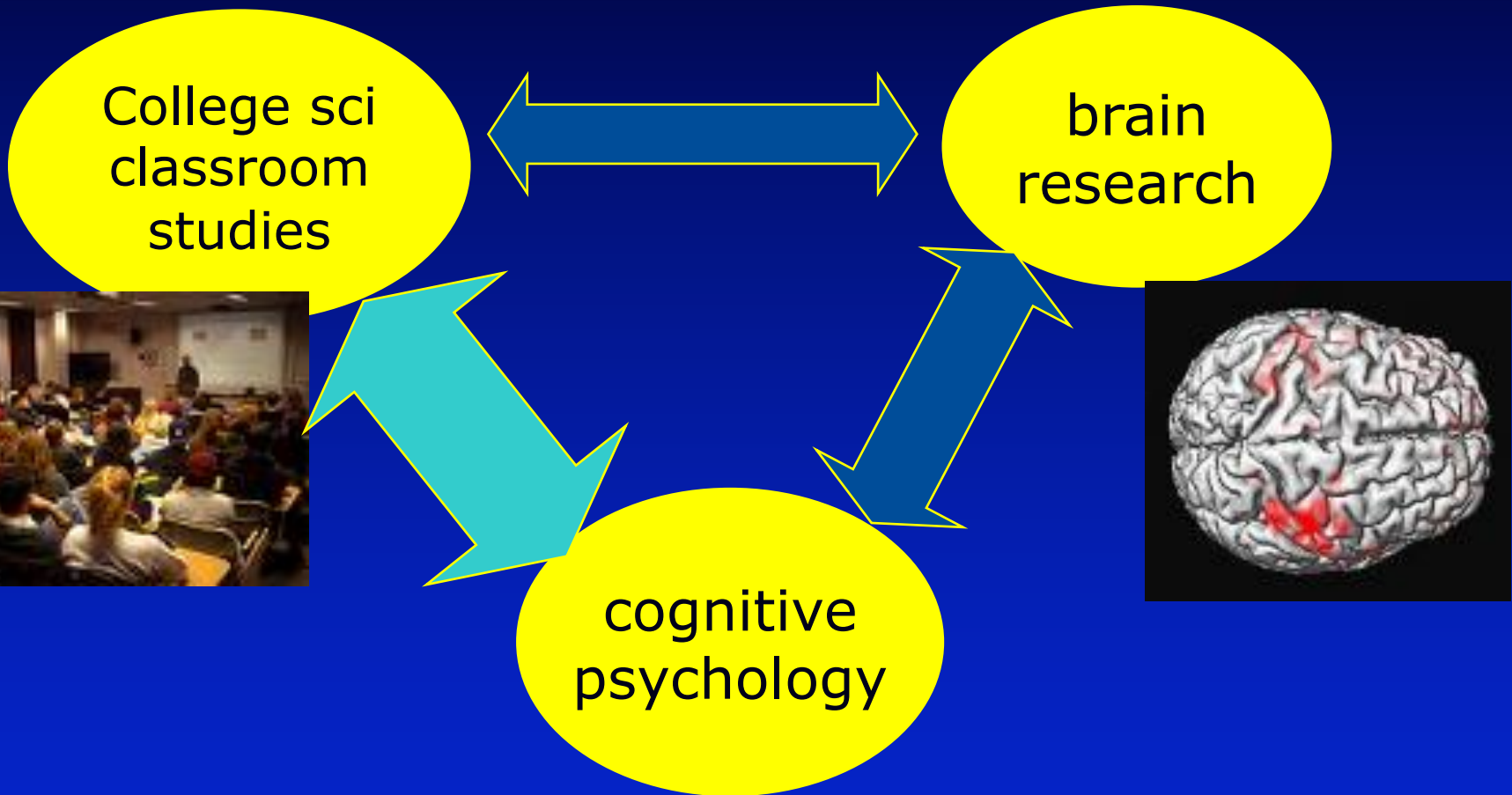

I. Exactly what is "*thinking like a scientist*" (our educational goal), or "*thinking like a good doctor*"

II. How is it learned? Guiding principles for teaching

III. Examples testing this in research in college science courses.

IV. New Wieman group research– adaptive expertise in medicine and science. Assessing and improving.

I. Expertise research*

historians, scientists, chess players, doctors,...

Expert competence =

- factual knowledge
- **Mental organizational framework** ⇒ retrieval and application



or ?



patterns, relationships,
scientific concepts

- Ability to monitor own thinking and learning**
("Do I understand this? How can I check?")

New ways of thinking-- everyone requires **MANY** hours of intense practice to develop.

Brain changed

*Cambridge Handbook on Expertise and Expert Performance

II. Learning expertise*--

Challenging but doable tasks/questions

Practicing all the elements of expertise with feedback and reflection.

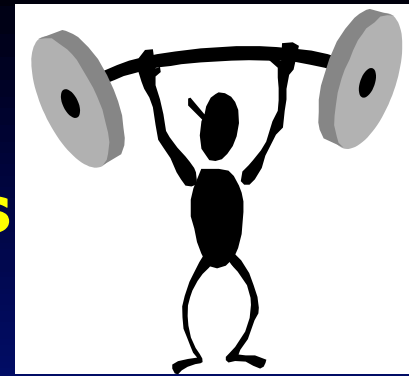

Requires brain
"exercise"

Some components of science expertise

- concepts and mental models + **selection criteria**
- recognizing what information is needed to solve, what irrelevant
- does answer/conclusion make sense- ways to test
- variations in complex normal, or novel & important?

Knowledge important but only as integrated part.
When and how to use.

* "Deliberate Practice", A. Ericsson research
accurate, readable summary in "Talent is over-rated", by Colvin

What is the role of the teacher in development of expertise?

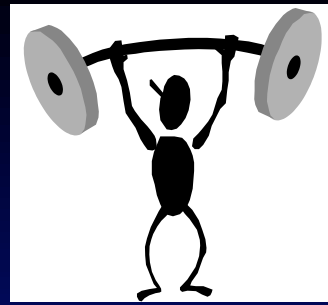

"cognitive coach". Designing practice tasks, motivating, giving feedback

Subject expertise of teacher is essential—

- designing practice tasks

(What is thinking like a doctor or med researcher? How to practice specific components & at proper level?)

- feedback/guidance on learner performance

Most important-- how to improve

3. Evidence from the Classroom

- ~ 1000 research studies undergrad science
- consistently show greater learning
- lower failure rates
- benefits all, but at-risk most

a few examples—

- learning from course
- learning in classroom

all sciences & eng.
similar.

PNAS Freeman, et. al.
recent massive meta-
analysis

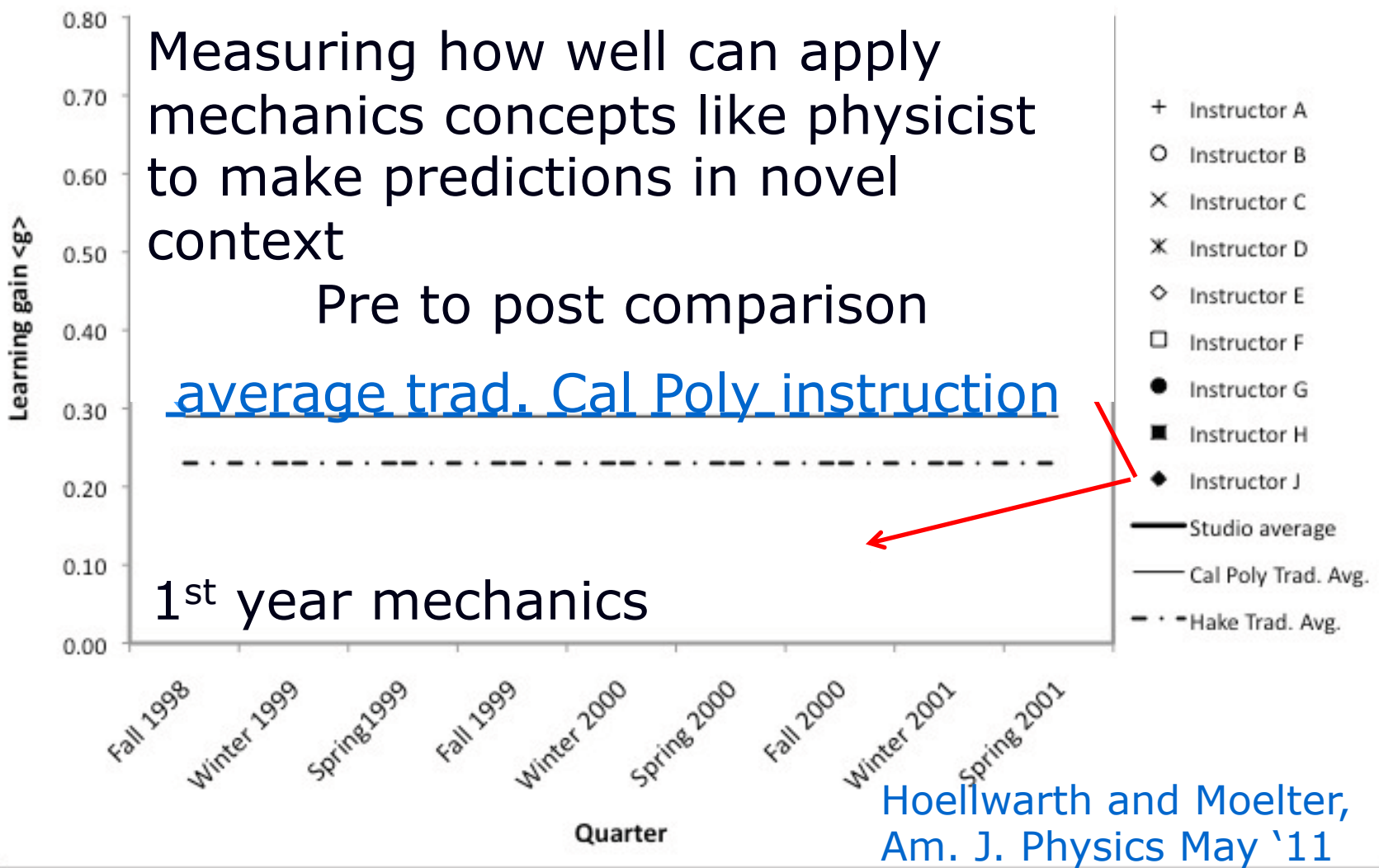

9 instructors, 8 terms, 40 students/section.
 Same instructors, different methods = better learning

Learning in the in classroom*

Comparing the learning in two identical sections of 1st year college physics. 270 students each.



Control--standard lecture class-- highly experienced Prof with good student ratings.

Experiment-- physics postdoc trained in principles & methods of effective teaching.

They agreed on:

- Same learning objectives
- Same class time (3 hours, 1 week)
- Same exam (jointly prepared)- start of next class

**Deslauriers, Schewlew, Wieman, Sci. Mag. May 13, '11*

Class design

1. Targeted pre-class readings, short online quiz.
2. Questions to solve, respond with clickers or on worksheets, discuss with neighbors.
Authentic questions- require expert thinking
3. Discussion by instructor follows, not precedes.
4. Activities address motivation (relevance) and prior knowledge.

Histogram of test scores

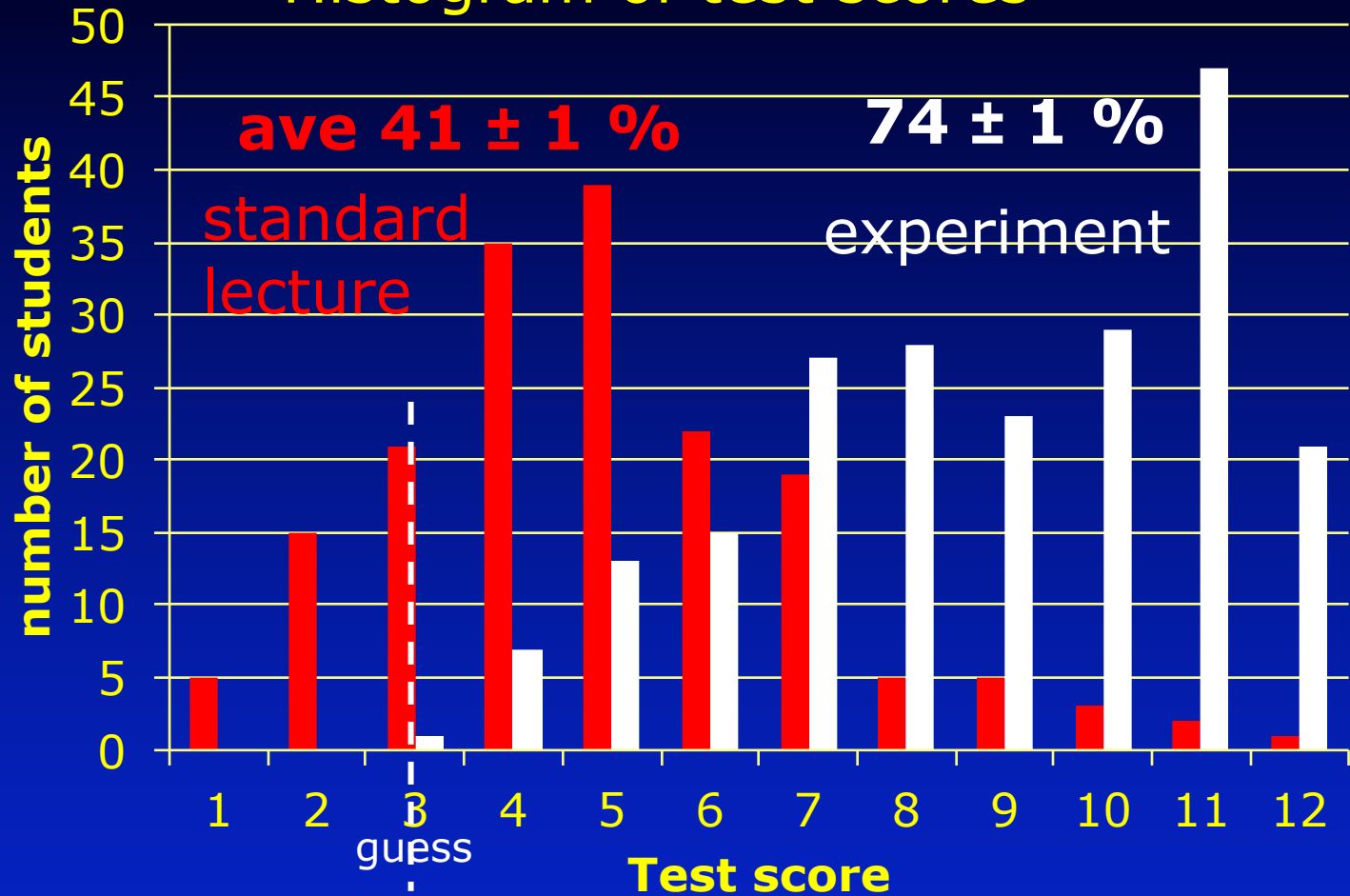

Clear improvement for entire student population.
Engagement 85% vs 45%.

Principles and methods also apply to more advanced topics and students (more relevant to medical education)--

Advanced courses 2nd -4th Yr physics

N = 20-100 Stanford & UBC



Design and implementation: Jones, Madison, Wieman, Transforming a fourth year modern optics course using a deliberate practice framework, Phys Rev ST – Phys Ed Res, V. 11(2), 020108-1-16 (2015)

Format of Class Period

Class design

TABLE II. Progression through sequential stages of a typical class period. Each action of students and instructors is described in detail within text.

Actions	Time (min)	Students	Instructors/TA(s)
Preparation	—	Complete targeted reading and pre-class online quizzes	Formulate/review activities
Introduction	2-3	Listen/ask questions	Introduce goals of day
Activity	10-15	Group work on activities	Circulate in classroom, answer questions and assess students
Feedback	5-15	Listen/ask questions, provide solutions and reasoning when called on	Facilitate whole class discussion, provide feedback to class
Activity	⋮	⋮	⋮
Feedback	⋮	⋮	⋮
<i>... repeat as needed ...</i>	⋮	⋮	⋮
Conclusion	2-3	Hand in in-class work	Wrap up

Final Exam Scores

nearly identical ("isomorphic") problems
(highly quantitative and involving transfer)

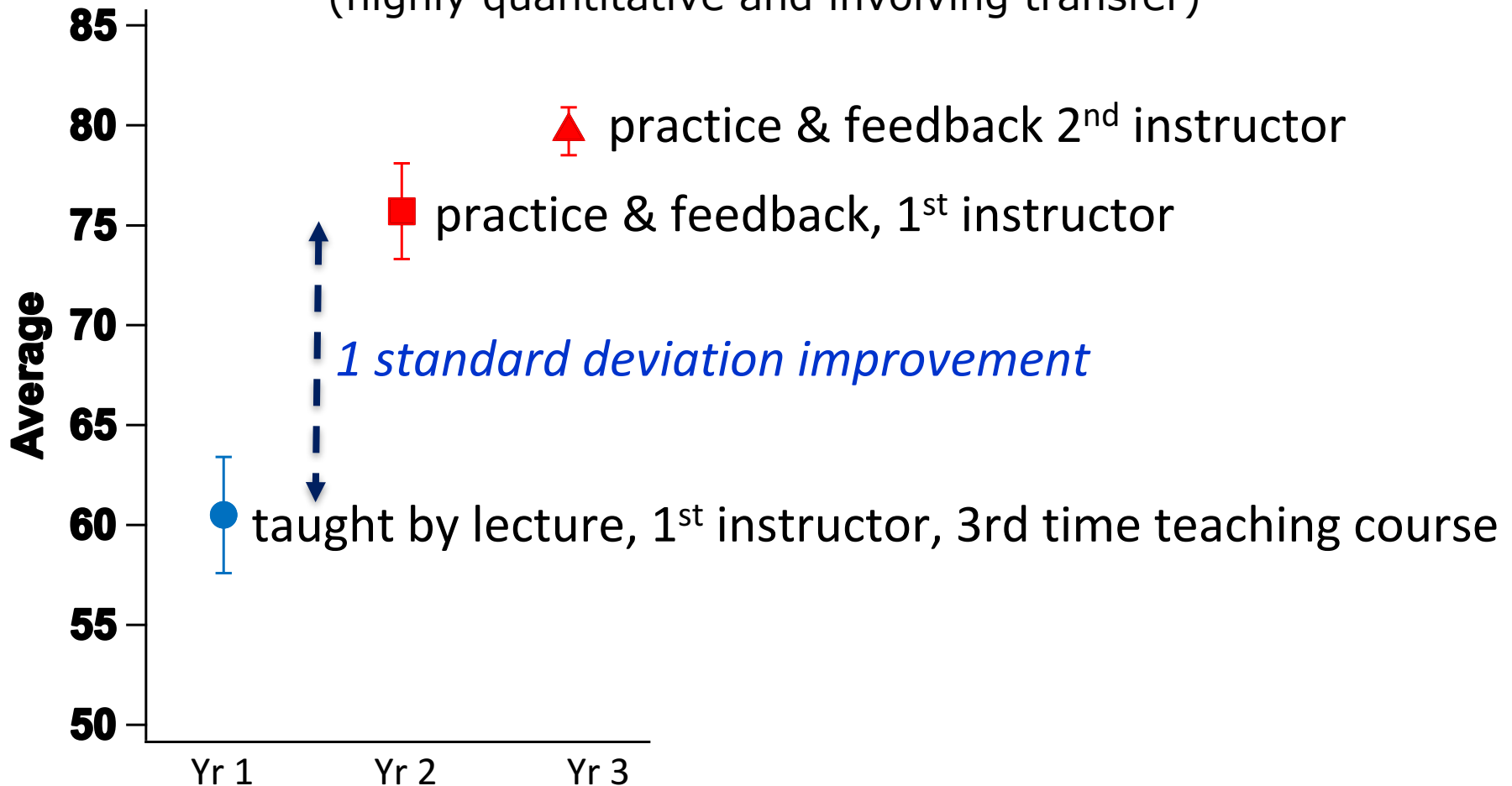

Jones, Madison, Wieman, Transforming a fourth year modern optics course using a deliberate practice framework, *Phys Rev ST – Phys Ed Res*, V. 11(2), 020108-1-16 (2015)

Stanford Active Learning Physics courses (all new in 2015-16)

2nd-4th year physics courses, 6 Profs

PHYS 70	Modern Physics	Wieman	Aut 2015	
PHYS 120	E&M I	Church	Win 2016	
PHYS 121	E&M II	Hogan	Spr 2016	
PHYS 130	Quantum I	Burchat	Win 2016	
PHYS 131	Quantum II	Hartnoll	Spr 2016	
PHYS 110	Adv Mechanics	Hartnoll	Aut 2015	
PHYS 170	Stat Mech	Schleier-Smith	Aut 2015	

Stanford Outcomes

- Attendance went from 50-60% to ~95% for all.
- Covered as much or more content
- Student anonymous comments:

**90% positive (mostly VERY positive, "All physics courses should be taught this way!")
only 4% negative**

- All the instructors (tenure-track Profs) greatly preferred to lecturing.

Typical response across ~ 200 faculty at UBC & U. Col. New way of teaching much more rewarding, would never go back.

Uses expertise much more directly.

How to make more effective teaching the norm--

A better way to evaluate undergraduate science teaching

Change Magazine, Jan-Feb. 2015

Carl Wieman

(also medical classroom teaching)

measure extent of use of practices that research shows lead to great learning

CBE—Life Sciences Education

Vol. 13, 552–569, Fall 2014

The Teaching Practices Inventory: A New Tool for Characterizing College and University Teaching in Mathematics and Science

<http://www.cwsei.ubc.ca/resources/TeachingPracticesInventory.htm>

Carl Wieman* and Sarah Gilbert†

*~10 min or less
to complete*

IV. New Wieman (and D. Schwartz) group research*

(medical & advanced undergrad sci & eng majors)

Collaborators welcome!

Assessing, then better teaching, of “adaptive expertise”

“Routine expertise”—fast and accurate on well-defined repetitive tasks. (*Board exams— set of model symptoms, match with diagnosis and treatment.*)

“Adaptive expertise”— recognize anomalies, recognize what need to learn, and learn effectively.

Assessment Scenario--Some model symptoms, some not

- Recognize anomalies?
- Guide selection of possible models of diagnosis by underlying science?
- Know what information to seek to constrain possibilities?
- How to best obtain that information?

then test teaching interventions

**Marty Keil*

A scientific approach to Science (Eng) teaching

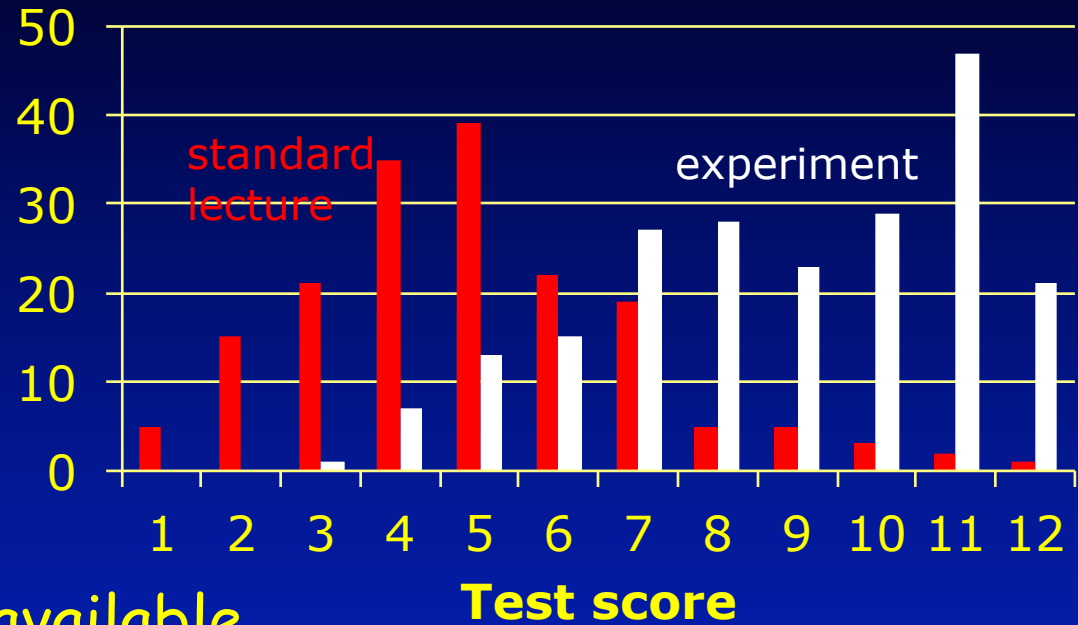
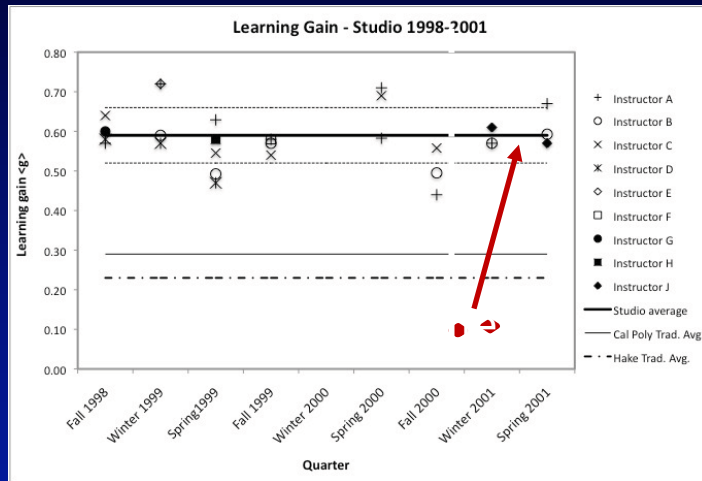

slides (+30 extras) available

Good References:

S. Ambrose et. al. "How Learning works"

D. Schwartz et al. "The ABCs of how we learn"

Colvin, "Talent is over-rated"

cwsei.ubc.ca-- resources, references, videos

<http://www.cwsei.ubc.ca/resources/TeachingPracticesInventory.htm>

~ 30 extras below

Learning outside of class (HW) also important

1. Expertise practiced and assessed with typical HW & exam problems.

- Provide all information needed, and only that information, to solve the problem
- Say what to neglect
- Not ask for argument for why answer reasonable
- Only call for use of one representation
- *Possible* to solve quickly and easily by plugging into equation/procedure

- ~~• concepts and mental models | selection criteria~~
- ~~• recognizing relevant & irrelevant information~~
- ~~• what information is needed to solve~~
- ~~• How I know this conclusion correct (or not)~~
- ~~• **model** development, testing, and use~~
- ~~• moving between specialized representations
(graphs, equations, physical motions, etc.)~~

Effective teaching practices, ETP, scores various math and science departments at UBC

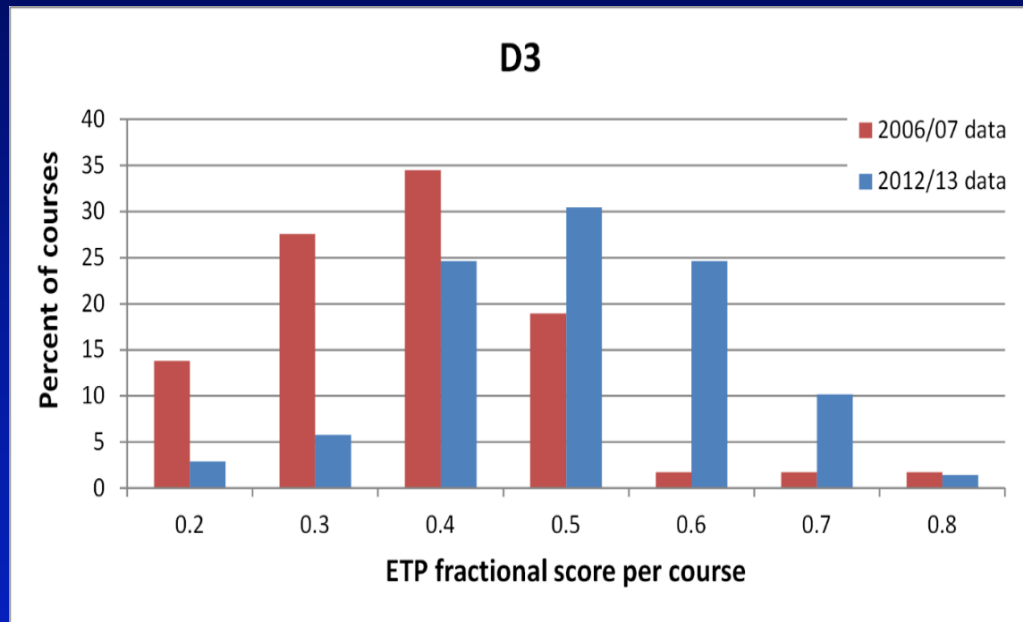
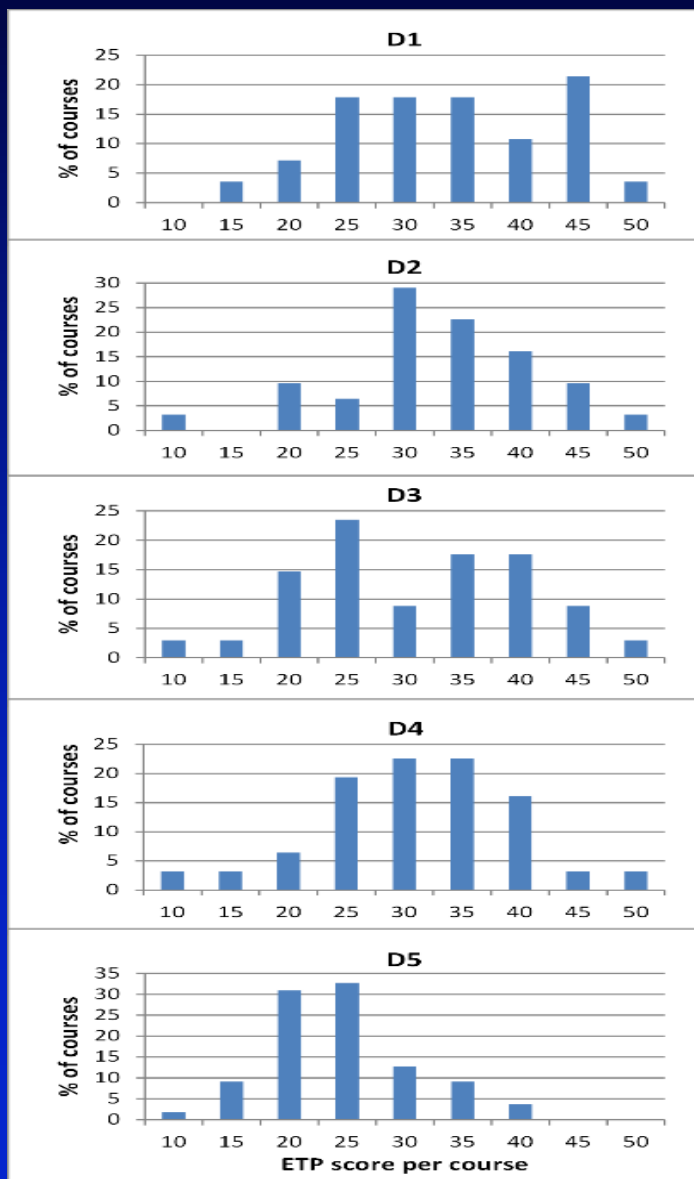

before and after for dept
that made serious effort
to improve teaching

Field and Phase in Optical Resonator-- Lecture

Lossy ("real life" or damped) Resonators

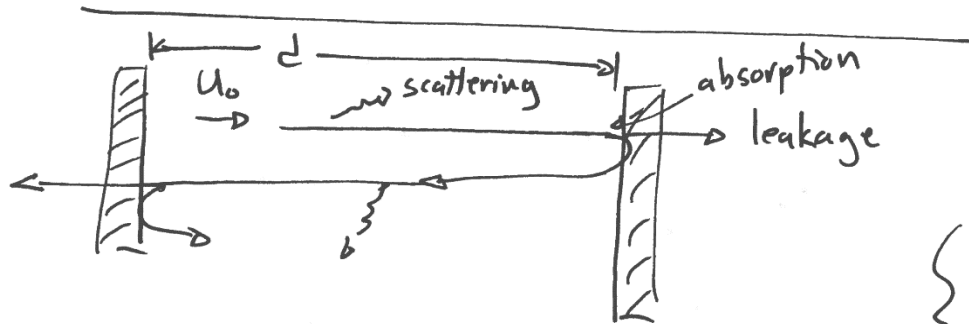

Amplitude of the field in one Round trip is reduced by

- absorption on mirrors
- leakage
- scattering

$$U_{n+1} = r e^{i\phi} U_n$$

so... $U_1 = U_0 r e^{i\phi}$

$$U_2 = U_1 r e^{i\phi} = U_0 r^2 e^{i2\phi}$$

⋮

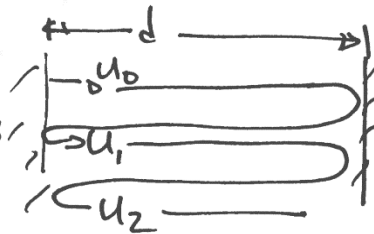

→ lump all of these effects into one factor \Rightarrow "r"
 - on each round trip

$$|U_{n+1}| = r |U_n|; \quad r < 1 \quad \underline{\text{real}} \quad \text{constant for each roundtrip}$$

- still have a longitudinal roundtrip phase
 $\phi = 2kd = \frac{4\pi\nu}{c} d$

to find total field in cavity:

$$U_T = U_0 + U_1 + U_2 + U_3 \dots$$

$$= U_0 + U_0 r e^{i\phi} + U_0 r^2 e^{i2\phi} + \dots; \quad h = r e^{i\phi}$$

$$= U_0 + h U_0 + h^2 U_0 + \dots$$

$$= \frac{U_0}{1-h}$$

$$U_T = \frac{U_0}{1 - r e^{i\phi}}$$

total field in cavity traveling to the right

Optical Resonator Derivation Activity (in-class)

3) Consider this optical setup

Laser with tunable frequency

mirror with r_1 field reflectivity & t_1 field transmission

mirror with r_2 field reflectivity

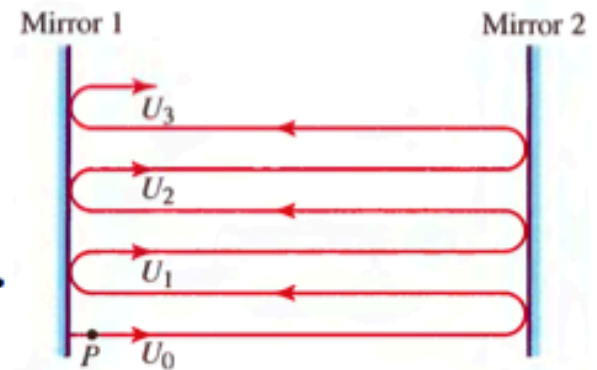
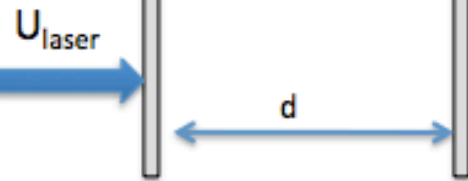

Steck writes the right moving wave amplitude in the cavity as

$$U = U_0 + U_1 + U_2 + \dots$$

where $U_{n+1} = r e^{i2kd} U_n$

3a) Explain what this second expression means:

3b) What is the meaning of the terms U_n and U_{n+1} ?

3c) What is U_0 in terms of r_1, r_2, t_1 , and U_{laser} ?

3d) What is r in terms of r_1 and r_2 ?

3e) Suppose there was a loss inducing optical element inside the cavity with a field transmission coefficient of t_{loss} . What would r be in terms of t_{loss}, r_1 and r_2 ? What if t_{loss} were complex?

3e) What is the effect of changing the index of refraction of the material between the mirrors? Is this equivalent to changing the distance between the mirrors? Why or why not?

3f) What is the effect of changing the wavelength of the input laser field? Is this equivalent to changing the distance between the mirrors? Why or why not?

3g) Evaluate the infinite sum for the field and derive an expression for the intensity

Hint $1 + a + a^2 + a^3 \dots = \frac{1}{1 - a}$

Necessary (and probably sufficient) 1st step-
have good way to evaluate teaching quality

Requirements:

- measures what leads to most learning
- equally valid/fair for use in all courses
- shows how to improve, & measures when do
- is practical to use on annual basis

method that currently dominates--student evaluations,
fails badly on first three (most important)

Better way– thoroughly characterize all the
practices and decisions used in teaching a course.
Determine extent of use of research-based methods
(*ones shown to improve learning*).

better proxy for what matters

III. How to apply in classroom?
*(best opportunity for feedback
& student-student learning)*

*example– large intro physics
class*



Teaching about electric current & voltage

1. Preclass assignment--Read pages on electric current. Learn basic facts and terminology without wasting class time. Short online quiz to check/reward.
2. Class starts with question:

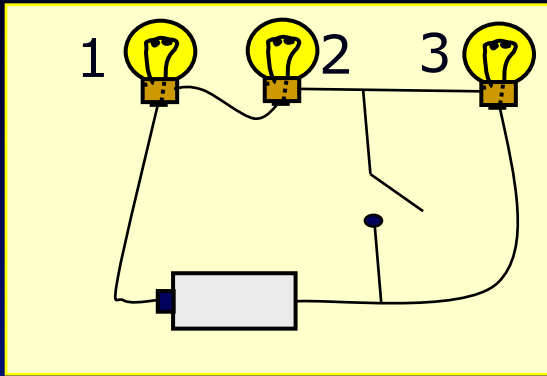

When switch is closed, bulb 2 will

- a. stay same brightness,
- b. get brighter
- c. get dimmer,
- d. go out.

answer & reasoning

3. Individual answer with clicker
(accountability=intense thought, primed for learning)

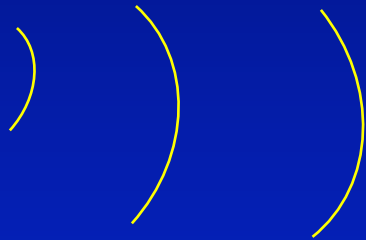
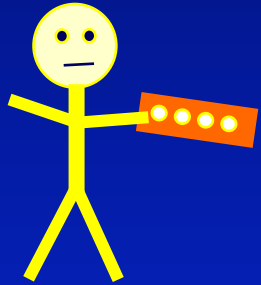

Jane Smith chose a.



4. Discuss with "consensus group", revote.
Listening in! What aspects of student thinking like physicist, what not?

5. Demonstrate/show result

6. Instructor follow up summary– feedback on which models & which reasoning was correct, & **which incorrect and why**. Many student questions.

Students practicing physicist thinking—

feedback that guides thinking—other students, informed instructor, demo

In class just the beginning. Building the same elements into homework and exams equally important.

U. Cal. San Diego, Computer Science

Failure & drop rates– *Beth Simon et al., 2012*

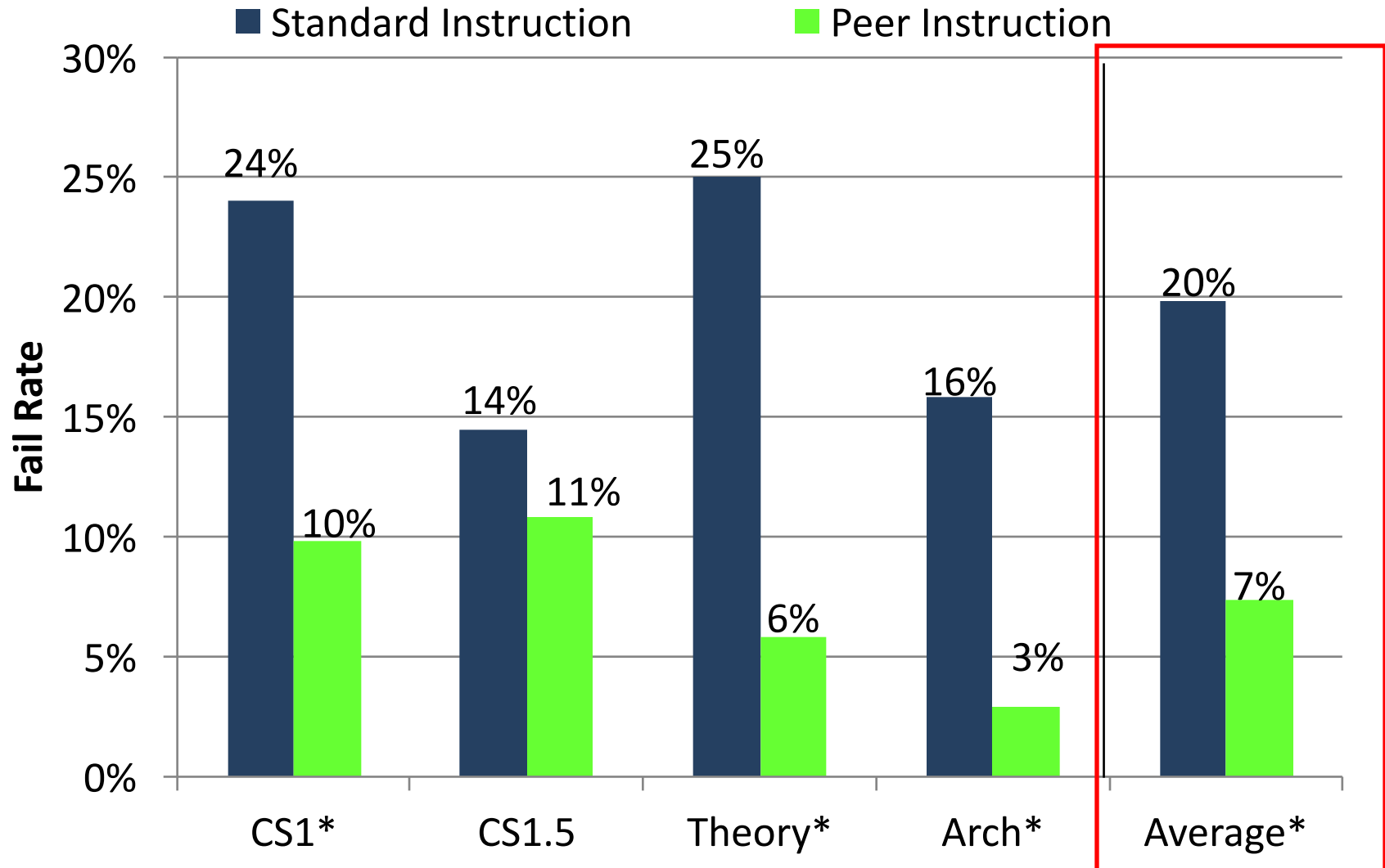

2. Limits on short-term working memory--best established, most ignored result from cog. science



Working memory capacity
VERY LIMITED!
*(remember & process
5-7 distinct new items)*

**MUCH less than in
typical lecture**

*slides to be
provided*

Mr Anderson, May I be excused?
My brain is full.

Reducing demands on working memory in class

- Targeted pre-class reading with short online quiz
- Eliminate non-essential jargon and information
- Explicitly connect
- Make lecture organization explicit.

How to apply cog. psych. principles in classroom?
(practicing expert thinking, with feedback)



Example from teaching about current & voltage--

1. Preclass assignment--Read pages on electric current. Learn basic facts and terminology. Short online quiz to check/reward (and retain).
2. Class built around series of questions & tasks.

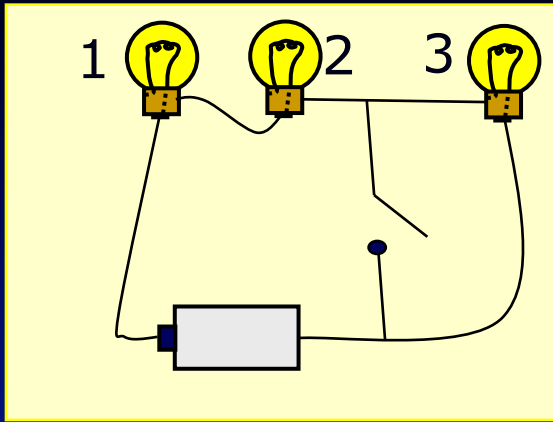

When switch is closed, bulb 2 will

- stay same brightness
- get brighter
- get dimmer,
- go out.

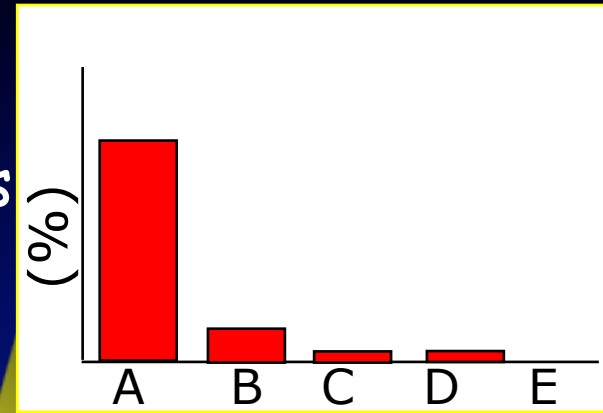

3. Individual answer with clicker
(*accountability, primed to learn*)

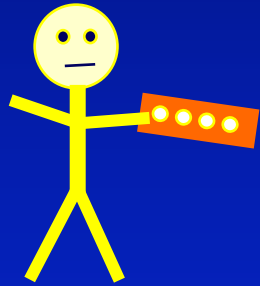

Jane Smith
chose a.

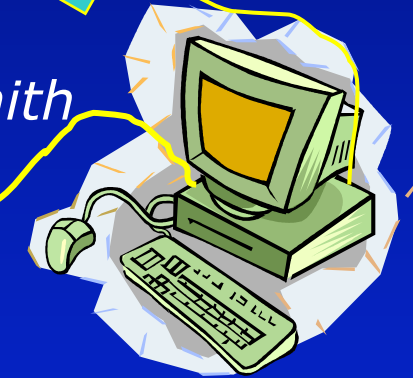

- Discuss with "consensus group", revote. (prof listen in!)
- Elicit student reasoning, discuss. Show responses. Do "experiment."-- cck simulation. Many questions.

How practicing thinking like a scientist?

- forming, testing, applying conceptual mental models, identifying relevant & irrelevant information, ...
- testing reasoning

+getting multiple forms of feedback to refine thinking

Still instructor talking (~ 50%), but **reactive**.

Requires much more subject expertise. Fun!



Perceptions about science

Novice

Content: isolated pieces of information to be memorized.

Handed down by an authority. Unrelated to world.

Problem solving: following memorized recipes.

Expert



Content: coherent structure of concepts.

Describes nature, established by experiment.

Prob. Solving: Systematic concept-based strategies.

measure student perceptions, 7 min. survey. Pre-post



best predictor of physics major



intro physics course \Rightarrow more novice than before

chem. & bio as bad

**adapted from D. Hammer*

Perceptions survey results–

Highly relevant to scientific literacy/liberal ed.
Correlate with everything important

Who will end up physics major 4 years later?

7 minute first day survey **better** predictor than
first year physics course grades

recent research ⇒ changes in instruction that
achieve positive impacts on perceptions

How to make perceptions significantly more like physicist (very recent)--

- process of science much more explicit (model development, testing, revision)
- real world connections up front & explicit

Student Perceptions/Beliefs

Kathy Perkins, M. Gratny

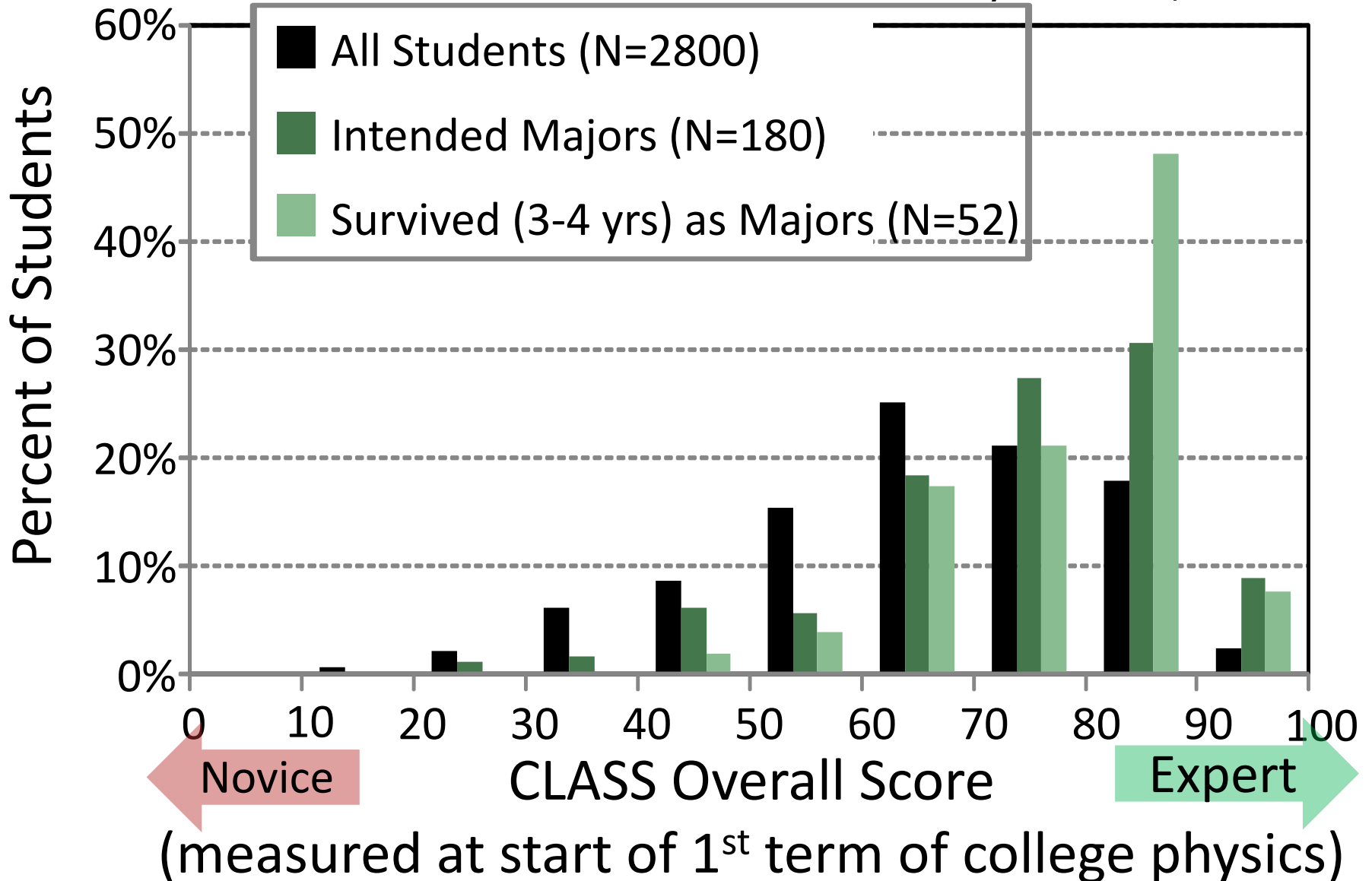

Student Beliefs

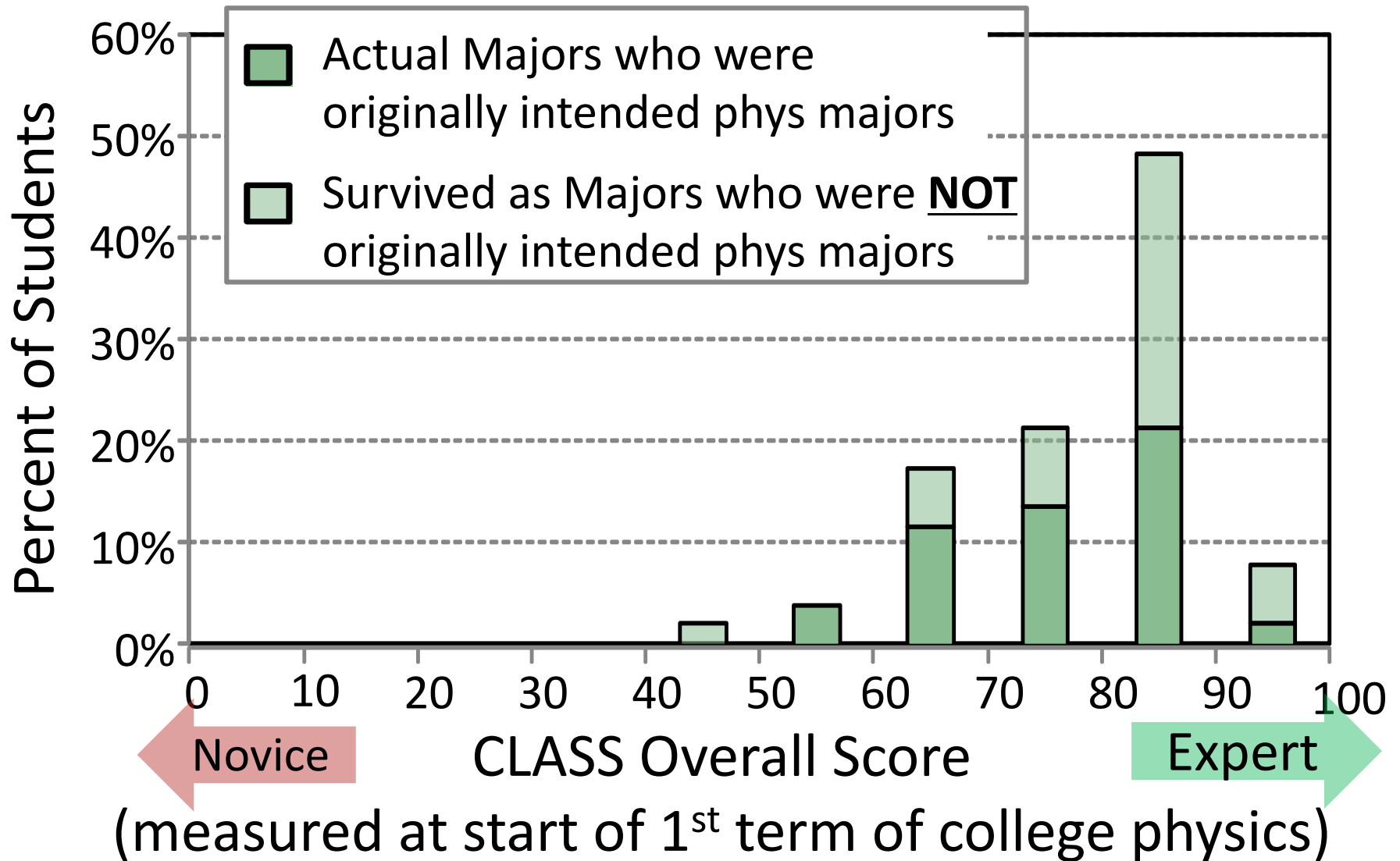

Emphasis on motivating students
Providing engaging activities and talking in class
Failing half as many
"Student-centered" instruction

Aren't you just coddling the students?

Like coddling basketball players by having them run up and down court, instead of sitting listening?

Serious learning is inherently hard work
Solving hard problems, justifying answers—**much**
harder, much more effort than just listening.

But also more rewarding (if understand value & what accomplished)--**motivation**

A few final thoughts—

1. Lots of data for college level,
does it apply to K-12?

*There is some data and it matches.
Harder to get good data, but cognitive psych
says principles are the same.*

2. Isn't this just "hands-on"/experiential/inquiry
learning?

*No. Is practicing thinking like scientist with feedback.
Hands-on may involve those same cognitive
processes, but often does not.*

Use of Educational Technology

Danger!

Far too often used for its own sake! (*electronic lecture*)
Evidence shows little value.

Opportunity

Valuable tool *if* used to supporting principles of effective teaching and learning.

Extend instructor capabilities.

Examples shown.

- Assessment (pre-class reading, online HW, clickers)
- Feedback (more informed and useful using above, enhanced communication tools)
- Novel instructional capabilities (PHET simulations)
- Novel student activities (simulation based problems)

New paradigm on learning complex tasks (e.g. science, math, & engineering)

old view, current teaching



knowledge

soaks in, variable

new view



transform via
suitable "exercise"

17 yrs of success in classes.
Come into lab clueless about physics?



2-4 years later \Rightarrow expert
physicists!

??????

17 yr

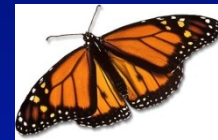

Research on how people learn, particularly physics

- explained puzzle
- different way to think about learning
- how to improve classes

Perfection in class is not enough!

Not enough hours

- Activities that prepare them to learn from class (targeted pre-class readings and quizzes)
- Activities to learn much more after class
 - good homework--**
 - builds on class
 - explicit practice of all aspects of expertise
 - requires reasonable time
 - reasonable feedback

Components of effective teaching/learning apply to all levels, all settings

1. Motivation
2. Connect with and build on prior thinking
3. Apply what is known about memory
 - a. short term limitations
 - b. achieving long term retention (Bjork)**
retrieval and application-- repeated & spaced in time (test early and often, cumulative)
4. Explicit authentic practice of expert thinking.
Extended & strenuous

Motivation-- essential

(complex- depends on background)

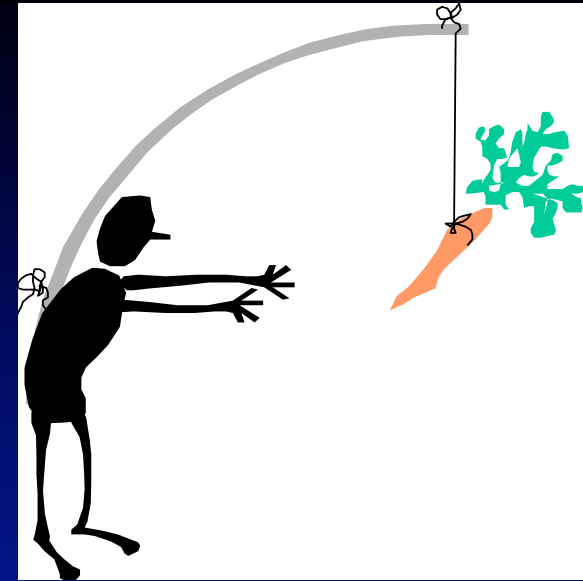

Enhancing motivation to learn

a. Relevant/useful/interesting to learner

(meaningful context-- connect to what they know and value)

requires expertise in subject

b. Sense that **can** master subject and how to master, recognize they are improving/accomplishing

c. Sense of personal control/choice

Survey of student opinions-- transformed section

"Q1. I really enjoyed the interactive teaching technique during the three lectures on E&M waves."

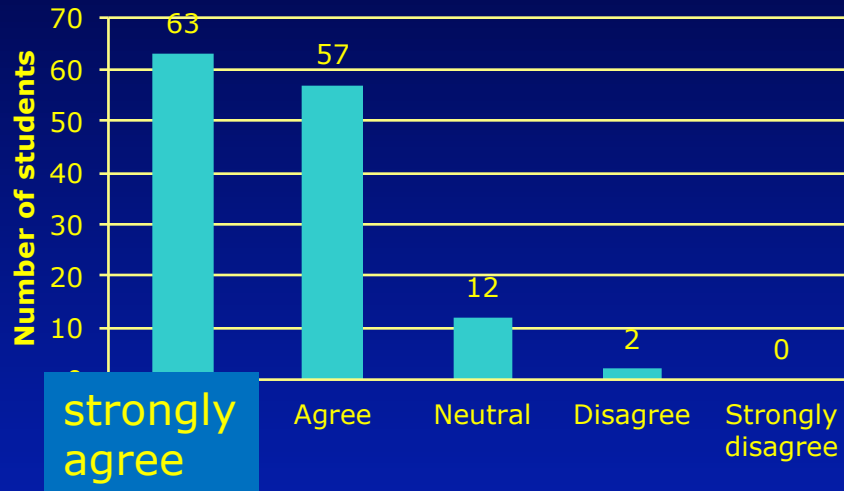

Not unusual for
SEI transformed
courses

How it is possible to cover as much material?

(if worrying about covering material not developing students expert thinking skills, focusing on wrong thing, but...)

- transfers information gathering outside of class,
- avoids wasting time covering material that students already know

Advanced courses-- often cover more

Intro courses, can cover the same amount.
But typically cut back by ~20%, as faculty understand better what is reasonable to learn.

Benefits to interrupting lecture with challenging conceptual question with student-student discussion

Not that important whether or not they can answer it, just have to engage.

Reduces WM demands– consolidates and organizes.
Simple immediate feedback (“what was mitosis?”)

Practice expert thinking. Primes them to learn.

Instructor listen in on discussion. Can understand and guide much better.

Highly Interactive educational simulations--
phet.colorado.edu >100 simulations
FREE, Run through regular browser. Download

Build-in & test that develop expert-like thinking and learning (*& fun*)

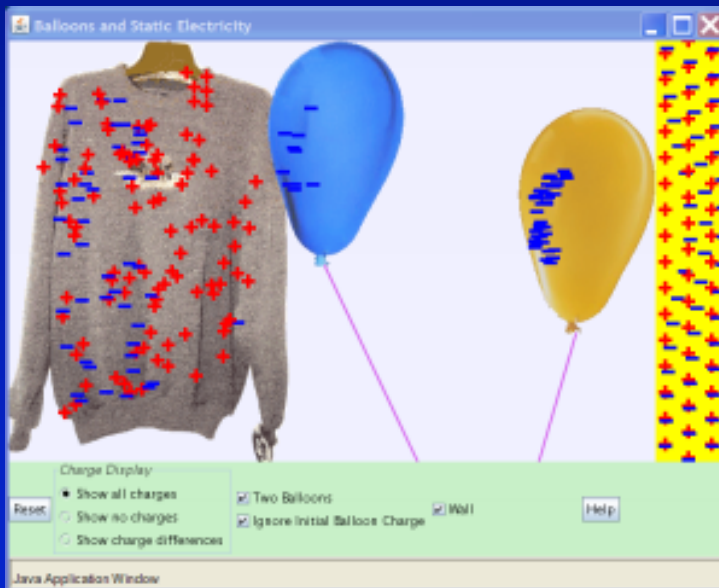

balloons and sweater

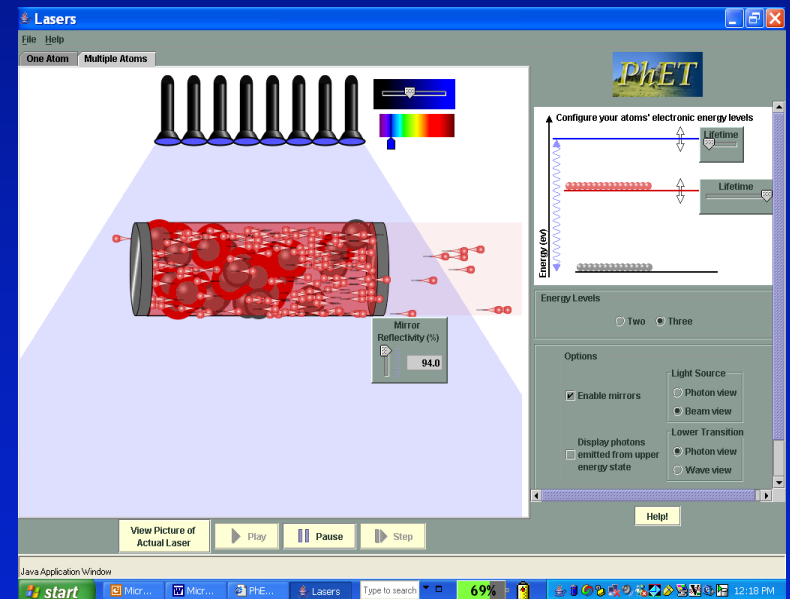

laser

clickers*--

Not automatically helpful--

give accountability, anonymity, fast response

Used/perceived as expensive attendance and testing device ⇒ little benefit, student resentment.

Used/perceived to enhance engagement, communication, and learning ⇒ transformative

- challenging questions-- concepts
- student-student discussion ("peer instruction") & responses (learning and feedback)
- follow up instructor discussion- timely specific feedback
- minimal but nonzero grade impact

*An instructor's guide to the effective use of personal response systems ("clickers") in teaching-- www.cwsei.ubc.ca

What is the role of the teacher?

“Cognitive coach”

- Designs tasks that practice the specific components, of “expert thinking”.
- Motivate learner to put in LOTS of effort
- Evaluates performance, provides timely specific feedback. Recognize and address particular difficulties (inappropriate mental models, ...)
- repeat, repeat, ...-- always appropriate challenge

Implies what is needed to teach well:
expertise, understanding how develops in people,
common difficulties, effective tasks and feedback,
effective motivation.

Why **so hard** to give up lecturing? (speculation)



1. tradition
2. Brain has no perspective to detect changes in self.
"Same, just more knowledge"
3. Incentives not to change—research is closely tracked, educational outcomes and teaching practices not.

Psychology research and our physics ed studies

Learners/experts cannot remember or believe previously held misunderstandings!

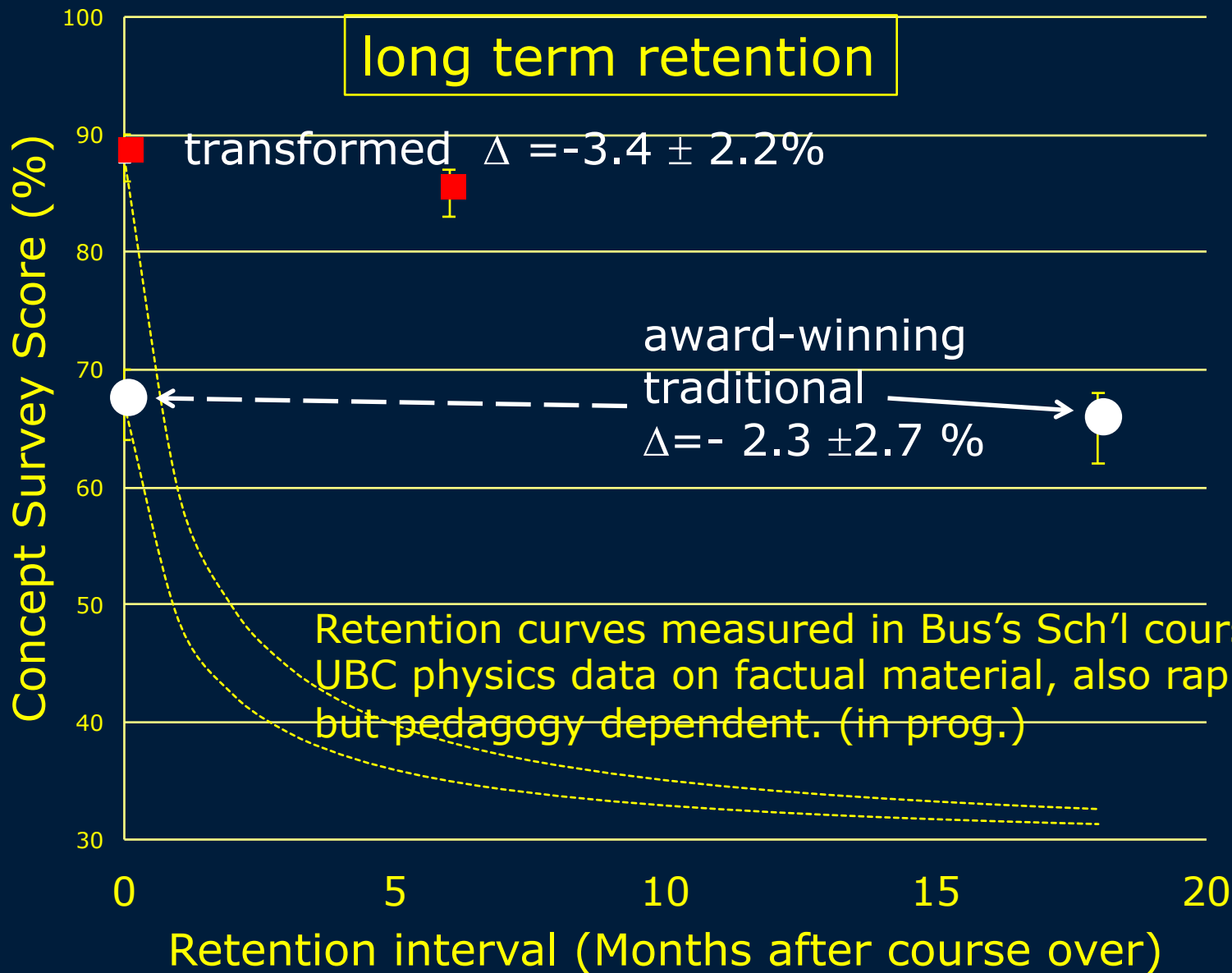

long term retention

transformed $\Delta = -3.4 \pm 2.2\%$

award-winning

traditional

$\Delta = -2.3 \pm 2.7\%$

Retention curves measured in Bus's Sch'l course.
UBC physics data on factual material, also rapid drop
but pedagogy dependent. (in prog.)

Comparison of teaching methods: identical sections (270 each), intro physics. (Deslauriers, Schewlew, submitted for pub)

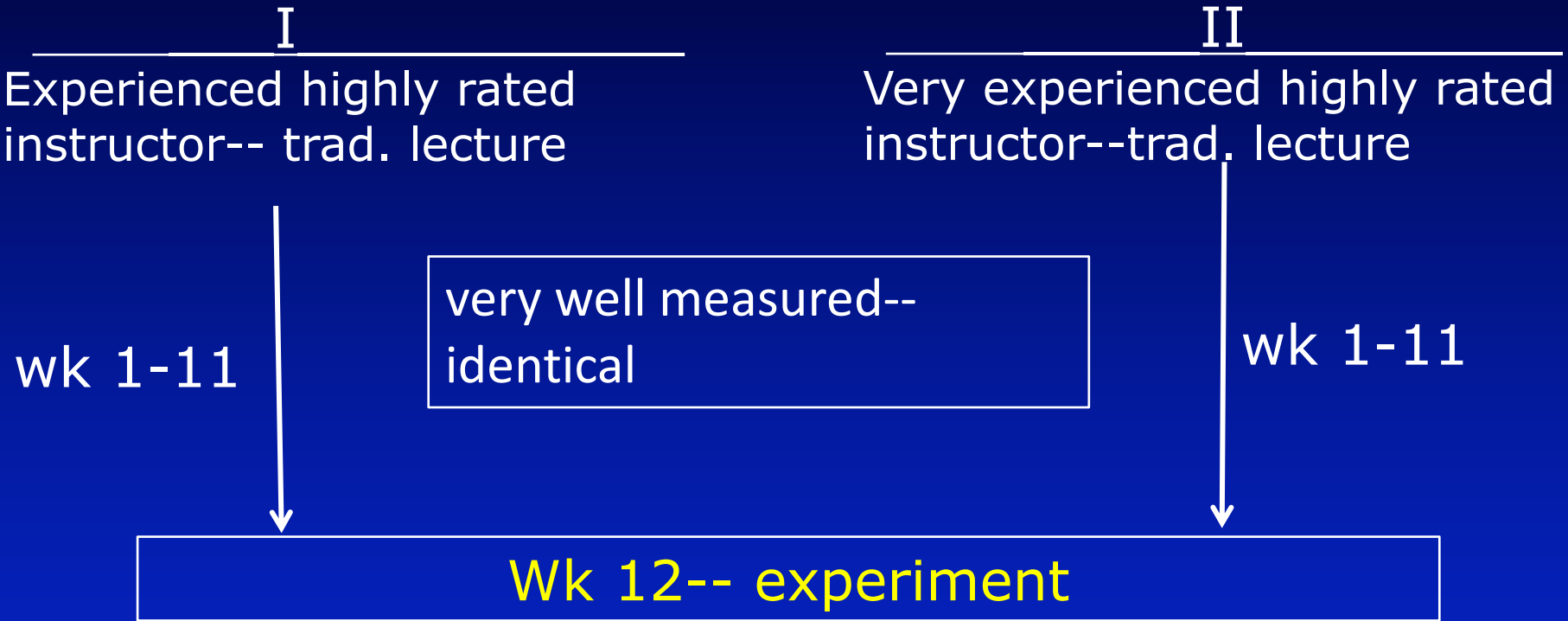

Two sections the same before experiment.
 (different personalities, same teaching method)

	Control Section	Experiment Section
Number of Students enrolled	267	271
Conceptual mastery(wk 10)	47± 1 %	47 ± 1%
Mean CLASS (start of term) (Agreement with physicist)	63±1%	65±1%
Mean Midterm 1 score	59± 1 %	59± 1 %
Mean Midterm 2 score	51± 1 %	53± 1 %
Attendance before	55±3%	57±2%
Engagement before	45±5 %	45±5 %

Comparison of teaching methods: identical sections (270 each), intro physics. (Deslauriers, Schewlew, submitted for pub)

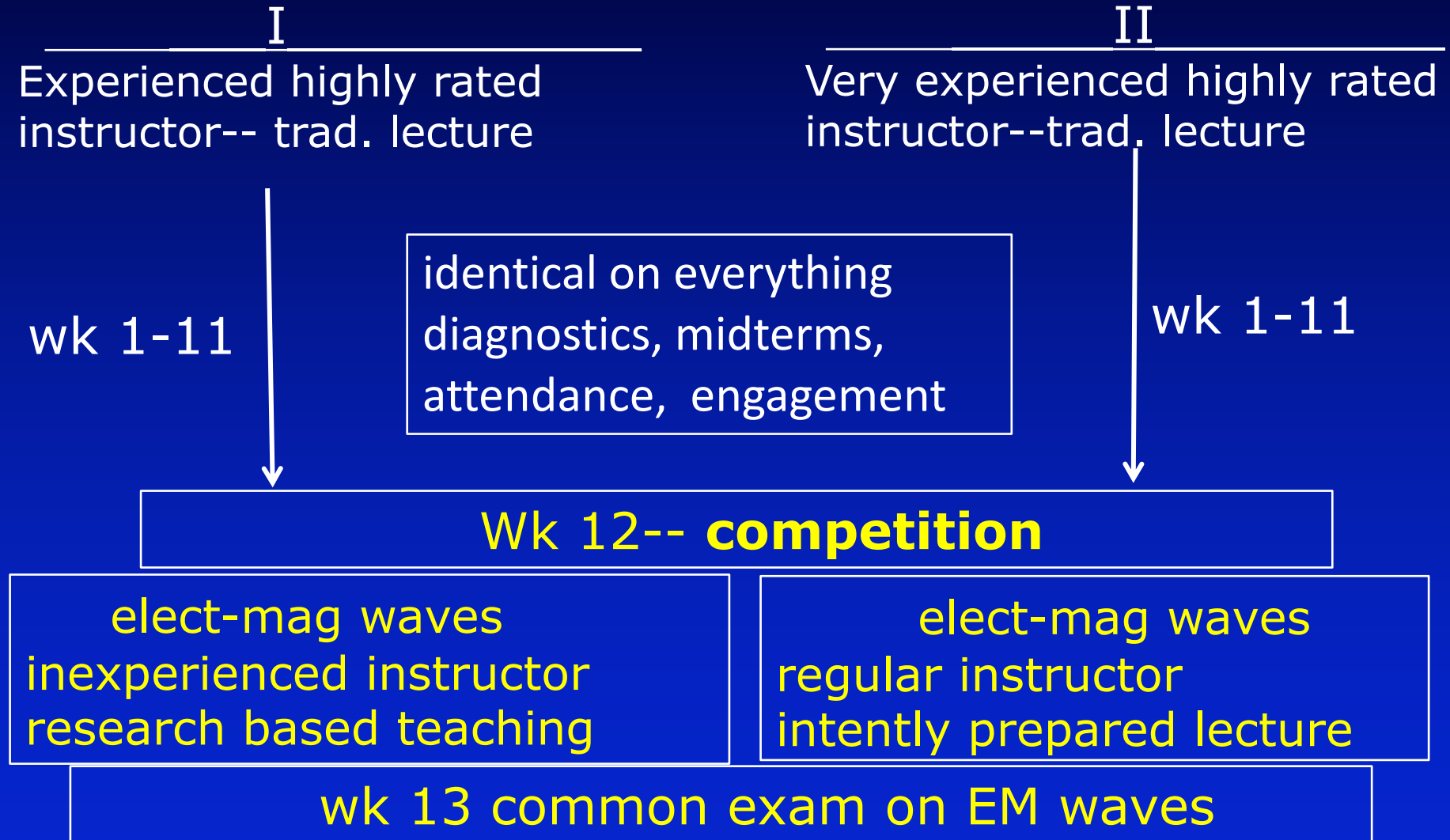

	<u>control</u>	<u>experiment</u>
2. Attendance	53(3) %	75(5)%
3. Engagement	45(5) %	85(5)%

Measuring student (dis)engagement. Erin Lane

Watch random sample group (10-15 students). Check against list of disengagement behaviors each 2 min.

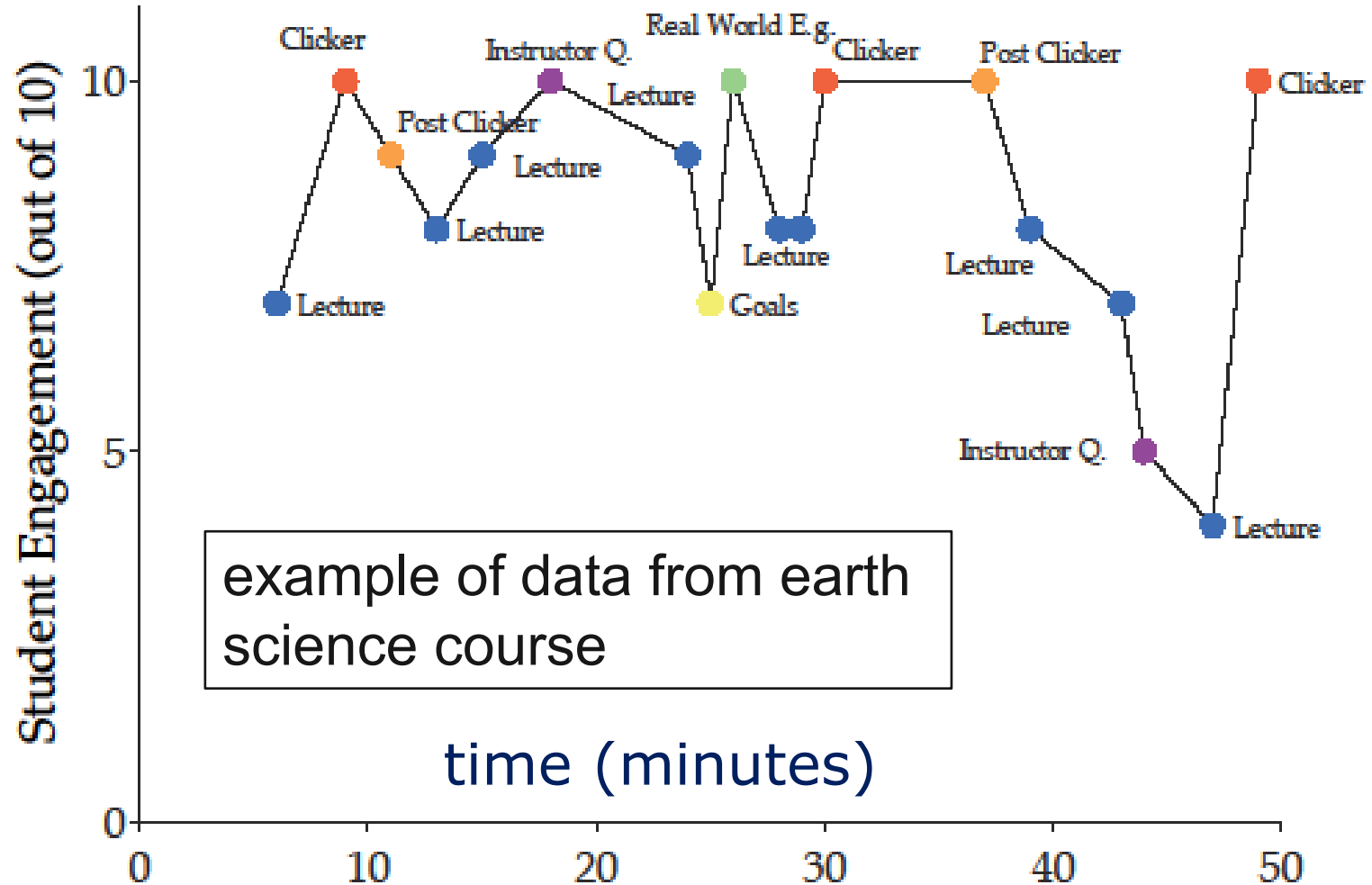

Design principles for classroom instruction

1. Move simple information transfer out of class. Save class time for active thinking and feedback.

2. "Cognitive task analysis"-- how does expert think about problems?

3. Class time filled with problems and questions that call for explicit expert thinking, address novice difficulties, challenging but doable, and are motivating.

4. Frequent specific feedback to guide thinking.

DP

What about learning to think more innovatively?

Learning to solve challenging novel problems

Jared Taylor and George Spiegelman

“Invention activities”-- practice coming up with mechanisms to solve a complex novel problem. Analogous to mechanism in cell.

2008-9-- randomly chosen groups of 30, 8 hours of invention activities.

This year, run in lecture with 300 students. 8 times per term. (video clip)

Plausible mechanisms for biological process student new encountered before

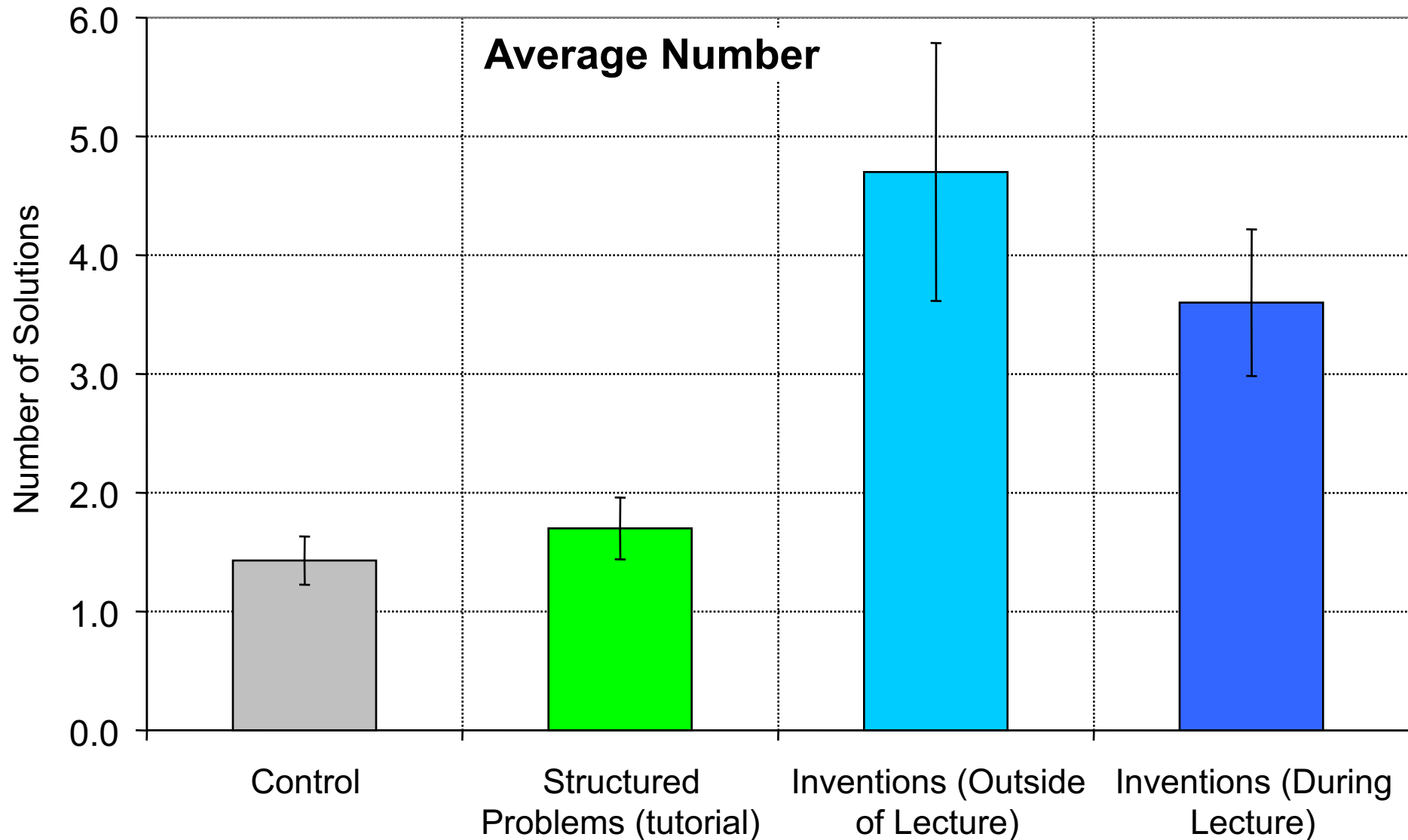

Average Time to First

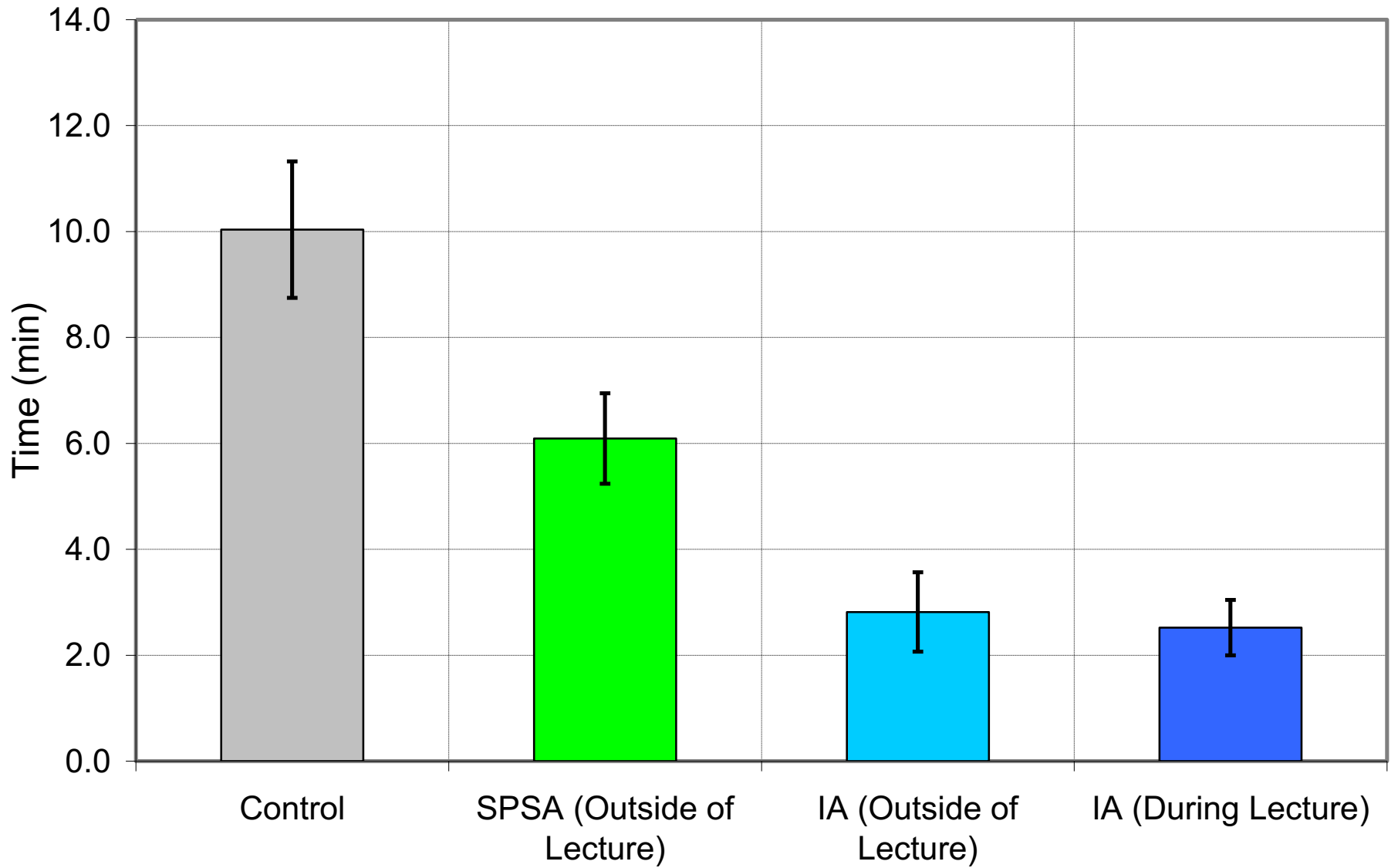

Bringing up the bottom of the distribution

"What do I do with the weakest students? Are they just hopeless from the beginning, or is there anything I can do to make a difference?"
*many papers showing things that **do not** work*

Here-- Demonstration of how to transform lowest performing students into medium and high.

Intervened with bottom 20-25% of students after midterm 1.

- a. very selective physics program 2nd yr course
- b. general interest intro climate science course

What did the intervention look like?

Email after M1-- "Concerned about your performance. 1) Want to meet and discuss";
or 2) 4 specific pieces of advice on studying. **[on syllabus]**

Meetings-- "*How did you study for midterm 1?*"
"mostly just looked over stuff, tried to memorize book & notes"

Give **small number** of **specific** things to do:

1. test yourself as review the homework problems and solutions.
2. test yourself as study the learning goals for the course given with the syllabus.
3. actively (explain to other) the assigned reading for the course.
4. Phys only. Go to weekly (optional) problem solving sessions.

Intro climate Science course (S. Harris and E. Lane)

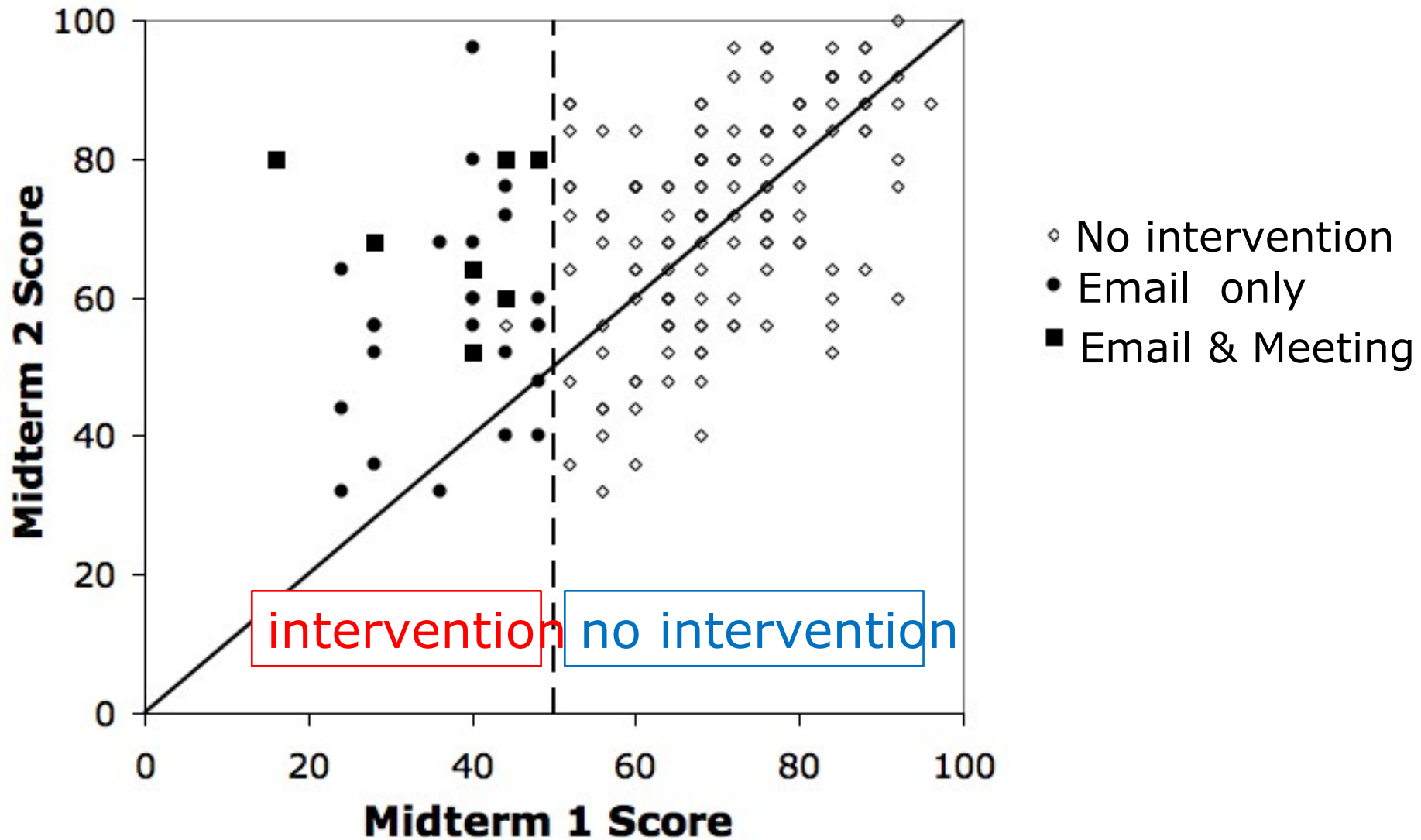

- End of 2nd yr Modern physics course (very selective and demanding, N=67)

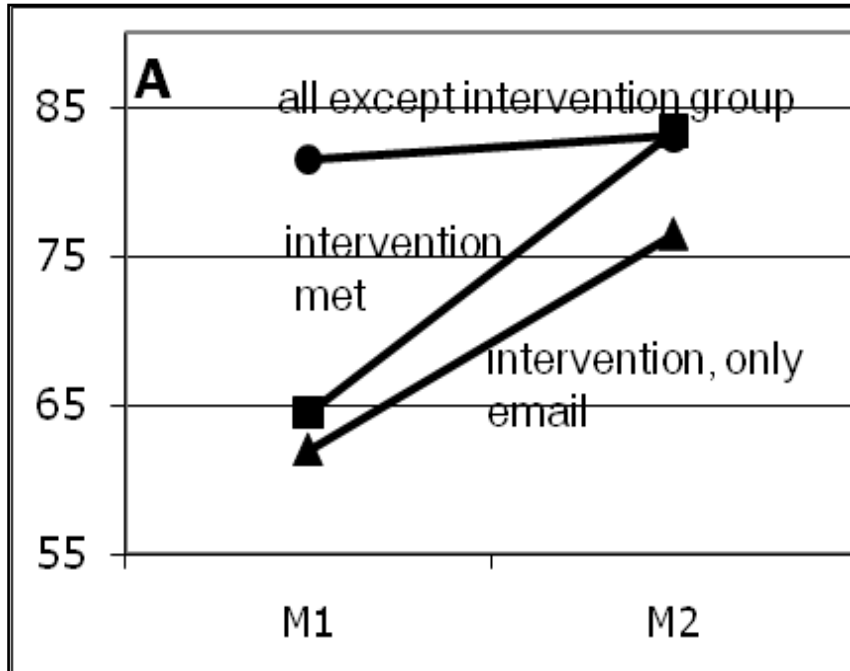

bottom 1/4 **averaged +19% improvement on midterm 2 !**

- Intro climate science course. Very broad range of students. (N=185)

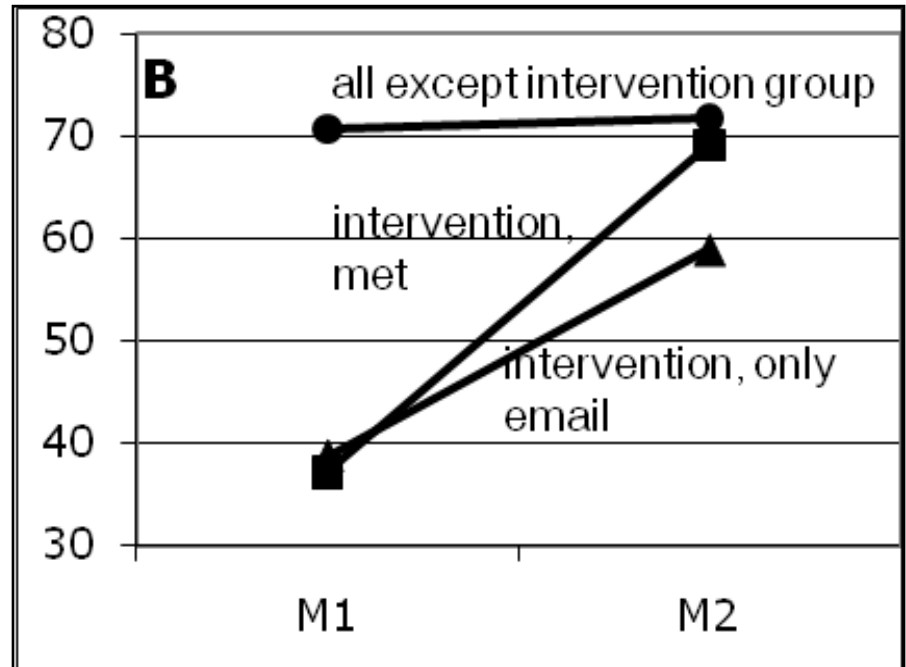

Averaged +30% improvement on midterm 2 !

Bunch of survey and interview analysis end of term.

⇒ students changed how they studied

*(but did not think this would work in most courses,
⇒ doing well on exams more about figuring out instructor
than understanding the material)*

Instructor can make a dramatic difference in the performance of low performing students with small but appropriately targeted intervention to improve study habits.

(lecture teaching) Strengths & Weaknesses

Works well for basic knowledge, prepared brain:



*bad,
avoid*



*good,
seek*

Easy to test. \Rightarrow Effective feedback on results.

Information needed to survive \Rightarrow intuition on teaching

But problems with approach if learning:

- involves complex analysis or judgment
- organize large amount of information
- ability to learn new information and apply

scientific
thinking

Complex learning-- different.

Reducing unnecessary demands on working memory improves learning.

~~jargon~~, use figures, analogies, pre-class reading

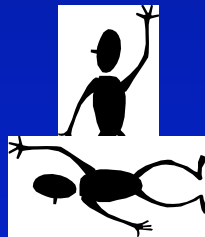
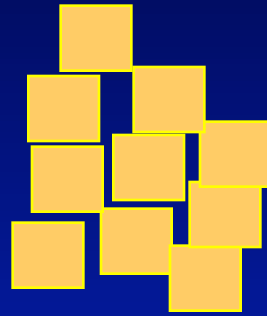
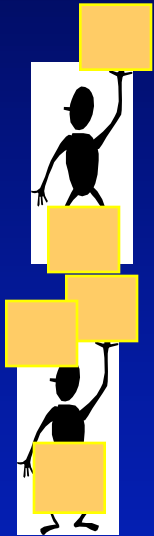

Characteristics of expert tutors* (Which can be duplicated in classroom?)

Motivation major focus (context, pique curiosity,...)

Never praise person-- limited praise, all for process

Understands what students do and do not know.

⇒ timely, specific, interactive feedback

Almost never tell students anything-- pose questions.

Mostly students answering questions and explaining.

Asking right questions so students challenged but can figure out. Systematic progression.

Let students make mistakes, then discover and fix.

Require reflection: how solved, explain, generalize, etc.

*Lepper and Woolverton pg 135 in Improving Academic Performance

UBC CW Science Education Initiative and U. Col. SEI

Changing educational culture in major research university science departments
necessary first step for science education overall

- Departmental level
⇒ **scientific approach to teaching, all undergrad courses = learning goals, measures, tested best practices**
Dissemination and duplication.

All materials, assessment tools, etc to be available on web

Institutionalizing improved research-based teaching practices. (*From bloodletting to antibiotics*)

Goal of Univ. of Brit. Col. CW Science Education Initiative (CWSEI.ubc.ca) & Univ. of Col. Sci. Ed. Init.

- Departmental level, widespread sustained change at major research universities
⇒ scientific approach to teaching, all undergrad courses
- Departments selected competitively
- Substantial one-time \$\$\$ and guidance

Extensive development of educational materials, assessment tools, data, etc. Available on web.

Visitors program

Fixing the system

but...need higher content mastery,
new model for science & teaching

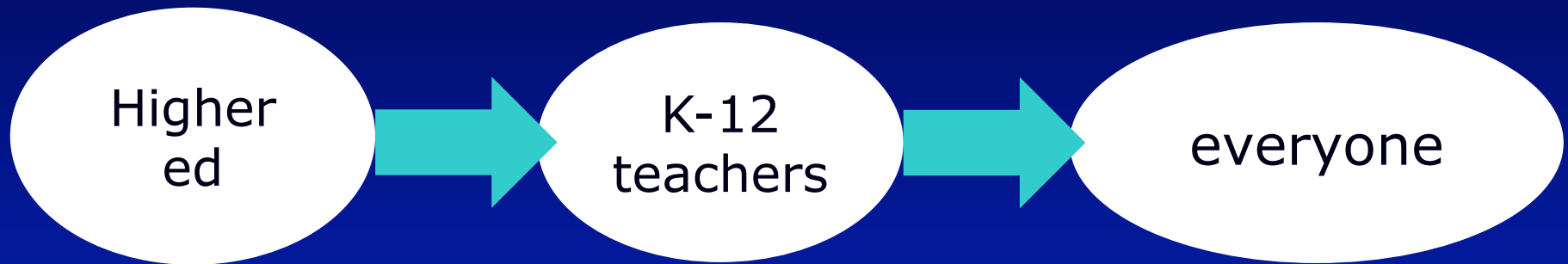

STEM teaching & teacher preparation

STEM higher Ed
Largely ignored, first step
Lose half intended STEM majors
Prof Societies have important role.

Many new efforts to improve undergrad stem education (partial list)

- 1. College and Univ association** initiatives (AAU, APLU) + many individual universities
- 2. Science professional societies**
- 3. Philanthropic Foundations**
- 4. New reports** —PCAST, NRC (~april)
- 5. Industry**– WH Jobs Council, Business Higher Ed Forum
- 6. Government**– NSF, Ed \$\$, and more
- 7. ...**

The problem with education—

Everyone is an expert--
countless opinions, all considered equally valid

Value of a scientific approach—
separate out reality from opinions

Scientific Approach

- theories
- experiments
- results
- revised theories more experiments
- finally reproducible and right

